

- | | |
|---------------------------------|------------------------|
| A. NONE OR LESS THAN
\$2,000 | K. \$11,000 - \$11,999 |
| B. \$2,200 - \$2,999 | L. \$12,000 - \$12,999 |
| C. \$3,000 - \$3,999 | M. \$13,000 - \$13,999 |
| D. \$4,000 - \$4,999 | N. \$14,000 - \$14,999 |
| E. \$5,000 - \$5,999 | O. \$15,000 - \$16,999 |
| F. \$6,000 - \$6,999 | P. \$17,000 - \$19,999 |
| G. \$7,000 - \$7,999 | Q. \$20,000 - \$22,999 |
| H. \$8,000 - \$8,999 | R. \$23,000 - \$24,999 |
| I. \$9,000 - \$9,999 | S. \$25,000 - \$34,999 |
| J. \$10,000 - \$10,999 | T. \$35,000 AND OVER |

1976-PRE



SURVEY RESEARCH CENTER
INSTITUTE FOR SOCIAL RESEARCH
THE UNIVERSITY OF MICHIGAN
ANN ARBOR, MICHIGAN 48106

1976-POST

RESPONDENT BOOKLET

P. 495456

1. YOUR HUSBAND OR WIFE
2. OTHER FAMILY OR RELATIVES
3. PEOPLE AT WORK
4. OTHER FRIENDS AND NEIGHBORS
7. OTHER: PLEASE SAY WHO IT WAS

1976-POST

HOW GOOD OR BAD A JOB IS BEING DONE FOR THE COUNTRY AS A WHOLE?

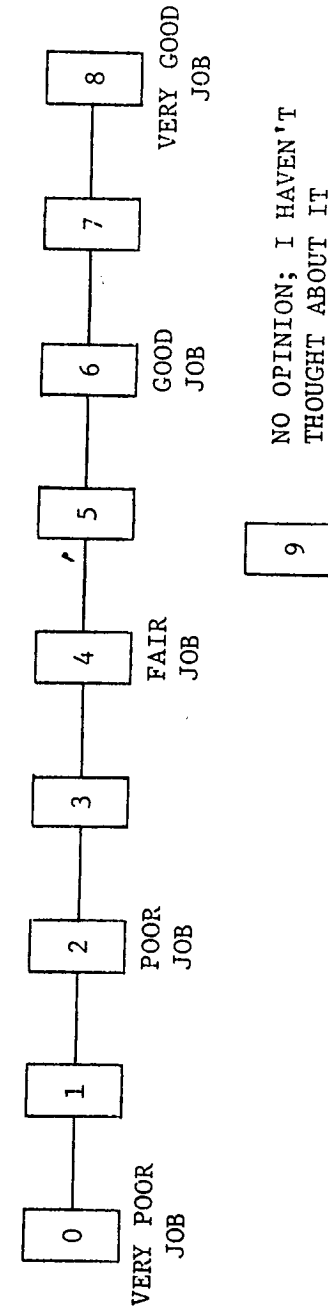

SHOULD HAVE

1. MUCH LESS INFLUENCE IN OUR SOCIETY
2. LESS INFLUENCE
3. A LITTLE LESS
4. SAME AS NOW
5. A LITTLE MORE
6. MORE INFLUENCE
7. MUCH MORE INFLUENCE IN OUR SOCIETY

9

NO OPINION; I HAVEN'T THOUGHT ABOUT IT

1976

GROUP INFLUENCE

1. TOO MUCH INFLUENCE
2. JUST ABOUT THE RIGHT AMOUNT OF INFLUENCE
3. TOO LITTLE INFLUENCE

POST

PARTS OF OUR GOVERNMENT

1. CONGRESS
2. THE SUPREME COURT
3. THE PRESIDENT
4. THE POLITICAL PARTIES

1. FREQUENTLY
2. SOMETIMES
4. RARELY
5. NEVER

1976

POST

1. FREQUENTLY
2. SOMETIMES
4. RARELY
5. NEVER

- a. HAD PROBLEMS WITH TRANSPORTATION TO THE POLLS
- b. HAD PROBLEMS GETTING TIME OFF FROM WORK TO VOTE
- c. LONG LINES AT POLLS TOOK TOO MUCH TIME
- d. WEATHER WAS BAD
- e. WAS OUT OF TOWN
- f. HAD FAMILY EMERGENCY OR ILLNESS
- g. WASN'T INTERESTED IN THE ELECTION
- h. FELT MY VOTE WOULDN'T MATTER IN THE ELECTION
- i. DIDN'T LIKE ANY OF THE CANDIDATES

1976

Post

- a. HAD PROBLEMS WITH TRANSPORTATION TO THE POLLS
- b. HAD PROBLEMS GETTING TIME OFF FROM WORK TO VOTE
- c. LONG LINES AT POLLS TOOK TOO MUCH TIME
- d. WEATHER WAS BAD
- e. WAS OUT OF TOWN; VOTED BY ABSENTEE BALLOT

- a. YOUR HUSBAND OR WIFE
- b. ANOTHER FAMILY MEMBER OR RELATIVE
- c. SOMEONE AT WORK
- d. OTHER FRIEND OR NEIGHBOR
- e. ANYONE ELSE: PLEASE SAY WHO IT WAS

1976

POST

1. CONGRESS
2. THE PRESIDENT
3. LABOR UNIONS
4. BIG BUSINESS

1. AGREE A GREAT DEAL
2. AGREE SOMEWHAT
4. DISAGREE SOMEWHAT
5. DISAGREE A GREAT DEAL

1976

POST

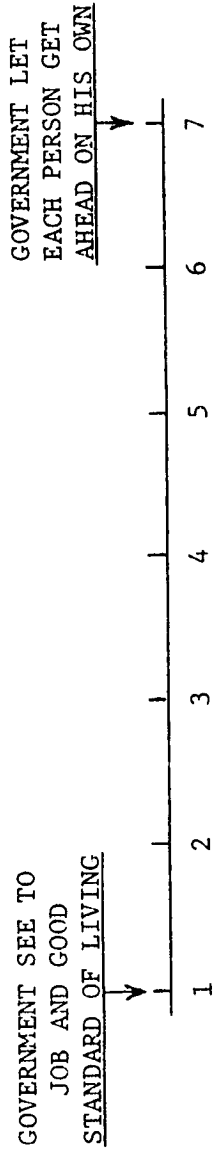

1976

Post

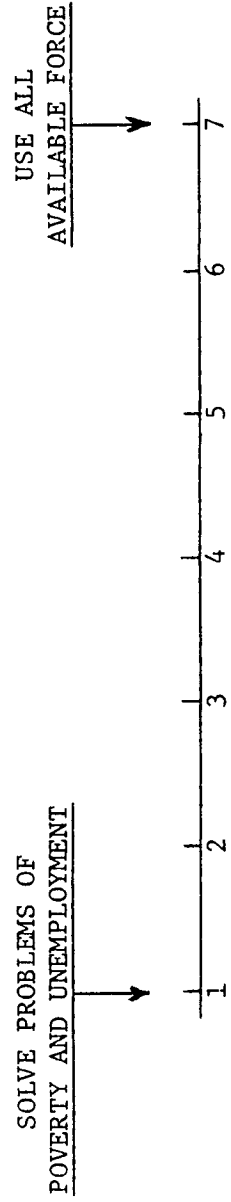

MAKE USE OF
MARIJUANA LEGAL

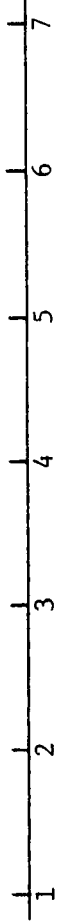

SET PENALTIES HIGHER
THAN THEY ARE NOW



1976 POST

INCREASE THE TAX RATE
FOR HIGH INCOMES



HAVE THE SAME TAX RATE
FOR EVERYONE



WOMEN'S PLACE
IS IN THE HOME

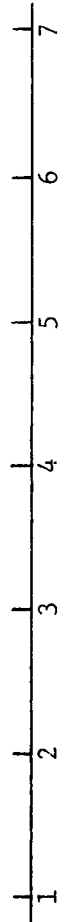

WOMEN AND MEN SHOULD
HAVE AN EQUAL ROLE



1. ABORTION SHOULD NEVER BE PERMITTED
2. ABORTION SHOULD BE PERMITTED ONLY IF THE LIFE AND HEALTH OF THE WOMAN IS IN DANGER
3. ABORTION SHOULD BE PERMITTED IF, DUE TO PERSONAL REASONS, THE WOMAN WOULD HAVE DIFFICULTY IN CARING FOR THE CHILD
4. ABORTION SHOULD NEVER BE FORBIDDEN, SINCE ONE SHOULD NOT REQUIRE A WOMAN TO HAVE A CHILD SHE DOESN'T WANT

1976 POST

"FEELING" THERMOMETER

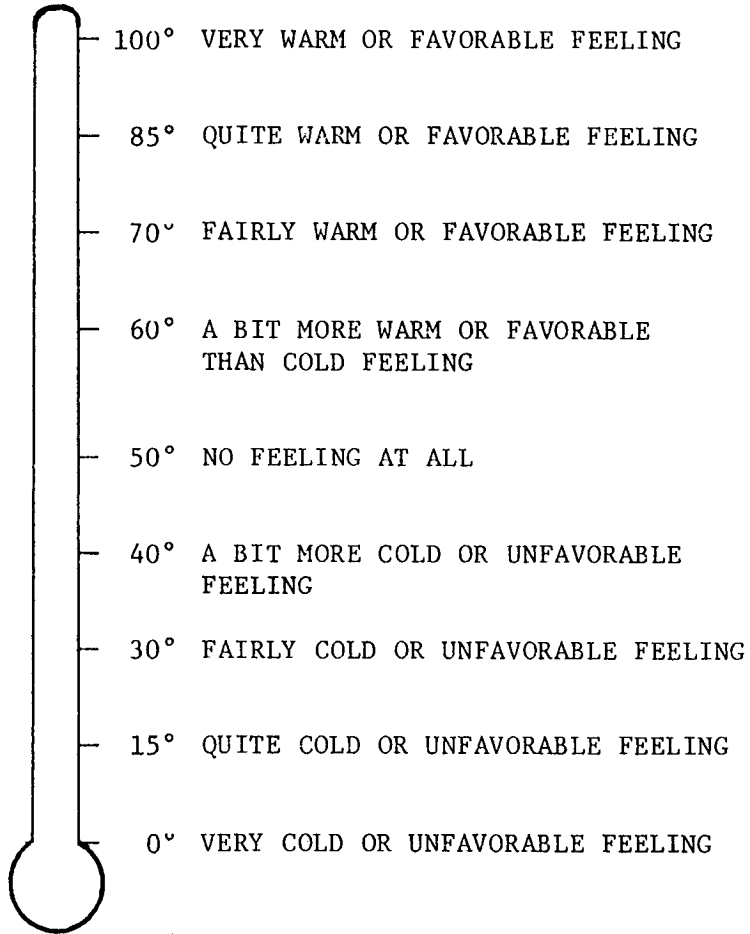

(there is no p. 20)

- a. BUSINESSMEN
- b. LIBERALS
- c. SOUTHERNERS
- d. POOR PEOPLE
- e. CATHOLICS
- f. PROTESTANTS
- g. JEWS
- h. YOUNG PEOPLE
- j. WHITES
- k. BLACKS
- m. CONSERVATIVES
- n. WOMEN
- p. MIDDLE CLASS PEOPLE
- q. WORKINGMEN
- r. FARMERS
- s. OLDER PEOPLE

1976

POST

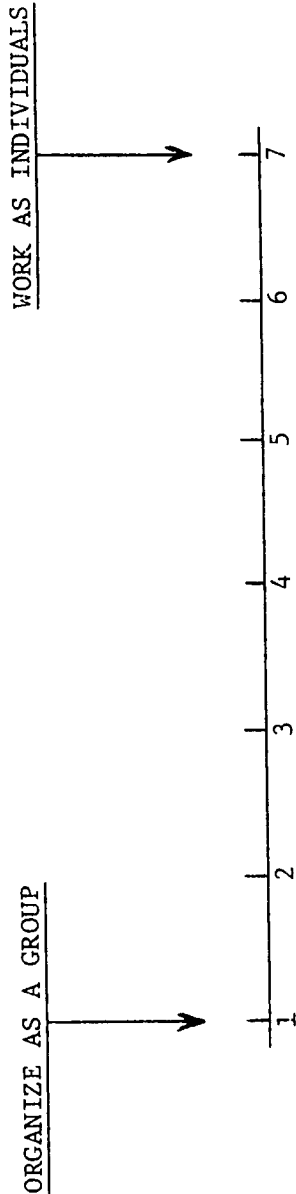

- a. GET MEMBERS TO VOTE AS A BLOC; SUPPORT A CANDIDATE ENDORSED BY THE GROUP
- b. REGISTER OTHER MEMBERS TO VOTE; GET MEMBERS TO THE POLLS ON ELECTION DAY
- c. ATTEND A PUBLIC MEETING OR DEMONSTRATION TO GET A LAW CHANGED OR PROTEST A POLICY YOUR GROUP OPPOSES
- d. GET YOUR GROUP TO WORK WITH OTHER GROUPS WITH SIMILAR INTERESTS
- e. MOVE TO ANOTHER COMMUNITY THAT BETTER REFLECTS YOUR GROUP'S INTERESTS
- f. WORK ON GROUP PROJECTS THAT HELP THE GROUP EXPRESS OR KEEP ALIVE ITS OWN VALUES

1976 POST

- a. BOUGHT A DOG FOR PURPOSES OF PROTECTION
- b. PUT NEW LOCKS ON WINDOWS OR DOORS
- c. PUT AN ALARM SYSTEM IN YOUR CAR, HOME OR APARTMENT
- d. KEPT A GUN FOR PURPOSES OF PROTECTION
- e. STAYED AWAY FROM CERTAIN AREAS IN A TOWN OR CITY

- a. WITNESSED A CRIME
- b. HAD YOUR HOME OR APARTMENT BROKEN INTO
- c. HAD YOUR CAR BROKEN INTO OR STOLEN
- d. WAS PHYSICALLY ATTACKED OR HAD SOMETHING TAKEN FROM YOU BY FORCE

1976 Post

- a. TO BE AMBITIOUS (A HARD WORKING, ASPIRING PERSON)
- b. TO BE WELL-LIKED (A FRIENDLY, PLEASANT PERSON)
- c. TO BE INDEPENDENT (A SELF-RELIANT, SELF-SUFFICIENT PERSON)
- d. TO BE HELPFUL (WORKING FOR THE BENEFIT OF OTHERS)
- e. TO BE RESPONSIBLE (A DEPENDABLE, RELIABLE PERSON)

- a. A PROSPEROUS LIFE (HAVING A GOOD INCOME AND BEING ABLE TO AFFORD THE GOOD THINGS IN LIFE)
- b. AN IMPORTANT LIFE (A LIFE OF ACHIEVEMENT THAT BRINGS ME RESPECT AND RECOGNITION)
- c. A SECURE LIFE (MAKING SURE THAT ALL BASIC NEEDS AND EXPENSES ARE PROVIDED FOR)
- d. AN EXCITING LIFE (A STIMULATING, ACTIVE LIFE)

1976 Post

1. MAINTAINING ORDER IN THE NATION
2. GIVING THE PEOPLE MORE SAY IN IMPORTANT POLITICAL DECISIONS
3. FIGHTING RISING PRICES
4. PROTECTING FREEDOM OF SPEECH

1976 POST